

ESKV-L 63

Cable gland, polyamide, M63, RAL 7001 with long thread

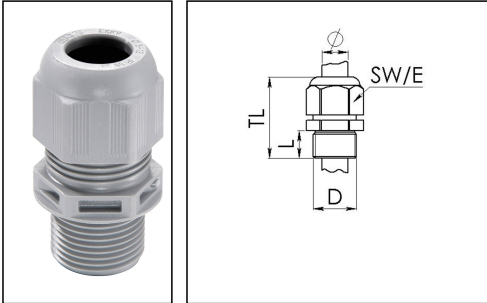

Product illustrations are exemplary and may differ from the chosen product. Further variants and individual customization, we will gladly provide you on request.



Material cable gland	Polyamide
Material sealing gasket	EPDM
Protection class	IP68 (5 bar 30 min), IP69
Temp. range min	-40 °C
Temp. range max	100 °C
Glow wire test	750 °C
Thread type	M
Ø Connection thread D	63
Lead	1,5
Length screw-in thread L	18 mm
Ø cable diameter min	34 mm
Ø cable diameter max	48 mm
Ø cable diameter UL	38,1 mm - 47,5 mm
Key width SW	68 mm
Collar diameter (E)	75 mm
Total length TL	67 mm - 81 mm
Type of cable anchorage	A
Install. torques fitting	30 N m
Install. torques cap nut	30 N m
Impact category	5
Equipment	Incl. connection thread gasket
Product Color	RAL 7001
Type	ESKV-L 63
Order no. RAL 7001	10066523
Packing unit	10

ETIM-Classification

EC000441

Recommended accessories

RDE 63	10062189
EMUG 63	10062719
BS 48	10064019
MFD 63/01/131-01/118-03/084-02/064	10101114
MFD 63/03/065	10101201
MFD 63/02/065-01/090	10101223

22.06.2018

