

ESKV 50 LT

Cable gland LowTemp, polyamide, M50, RAL 7035 with short thread

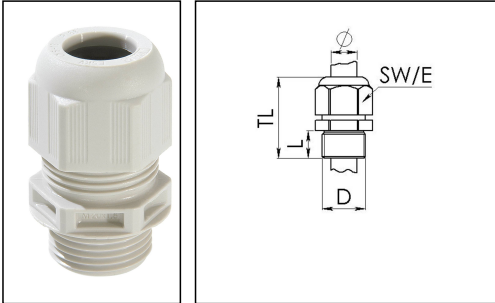

Product illustrations are exemplary and may differ from the chosen product. Further variants and individual customization, we will gladly provide you on request.



Material cable gland	Polyamide
Material sealing gasket	Silicone
Protection class	IP69, IP68 (5 bar 30 min)
Temp. range min	-60 °C
Temp. range max	100 °C
Glow wire test	750 °C
Thread type	M
Ø Connection thread D	50
Lead	1,5
Length screw-in thread L	14 mm
Ø cable diameter min	21 mm
Ø cable diameter max	35 mm
Key width SW	55 mm
Collar diameter (E)	61 mm
Total length TL	59 mm - 72 mm
Type of cable anchorage	A
Install. torques fitting	30 N m
Install. torques cap nut	30 N m
Impact category	5
Equipment	Incl. connection thread gasket
Product Color	RAL 7035
Type	ESKV 50 LT
Order no. RAL 7035	10062782
Packing unit	4
ETIM-Classification	EC000441

Recommended accessories

RDE 50 LT	10063966
BS 35	10064017

24.04.2018

