

ESKV-L 20 LT

Cable gland LowTemp, polyamide, M20, RAL 7035 with long thread

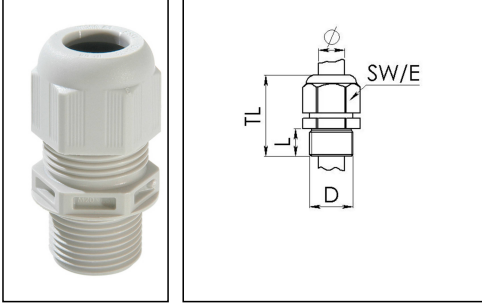

Product illustrations are exemplary and may differ from the chosen product. Further variants and individual customization, we will gladly provide you on request.



Material cable gland	Polyamide
Material sealing gasket	Silicone
Protection class	IP69, IP68 (5 bar 30 min)
Temp. range min	-60 °C
Temp. range max	100 °C
Glow wire test	750 °C
Thread type	M
Ø Connection thread D	20
Lead	1,5
Length screw-in thread L	15 mm
Ø cable diameter min	6 mm
Ø cable diameter max	13 mm
Key width SW	24 mm
Collar diameter (E)	27 mm
Total length TL	41 mm - 50 mm
Type of cable anchorage	A
Install. torques fitting	4 N m
Install. torques cap nut	3 N m
Impact category	3
Product Color	RAL 7035
Type	ESKV-L 20 LT
Order no. RAL 7035	10062739
Packing unit	50
ETIM-Classification	EC000441

Your Contact:

WISKA Systems Ibérica, S. L.

Mr. Javier Cebrián · C/ Roquetes Nave 117 – Pol. Ind. Can Magre · 08187 Sta. Eulalia de Ronçana · Barcelona, España

☎ +34 (93) 844 65 73 · 📠 +34 (93) 844 86 77

contact@wiska.es · www.wiska.es

Recommended accessories

RDE 20 LT	10063909
BS 13	10064010
EADR 20/90 LT	10105706

18.11.2018

Your Contact:

WISKA Systems Ibérica, S. L.

Mr. Javier Cebrián · C/ Roquetes Nave 117 – Pol. Ind. Can Magre · 08187 Sta. Eulalia de Ronçana · Barcelona, España

☎ +34 (93) 844 65 73 · 📠 +34 (93) 844 86 77

contact@wiska.es · www.wiska.es



Your Contact:

WISKA Systems Ibérica, S. L.

Mr. Javier Cebrián · C/ Roquetes Nave 117 – Pol. Ind. Can Magre · 08187 Sta. Eulalia de Ronçana · Barcelona, España

☎ +34 (93) 844 65 73 · 📠 +34 (93) 844 86 77

contact@wiska.es · www.wiska.es