

ESKV-L 63 LT

Cable gland LowTemp, polyamide, M63, RAL 9005 with long thread

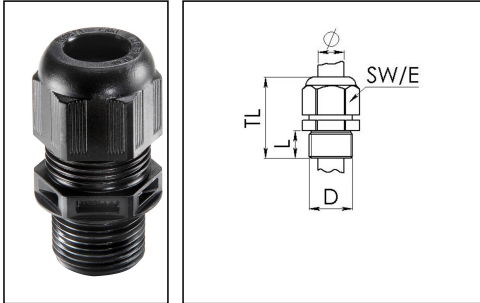

Product illustrations are exemplary and may differ from the chosen product. Further variants and individual customization, we will gladly provide you on request.



Material cable gland	Polyamide
Material sealing gasket	Silicone
Protection class	IP69, IP68 (5 bar 30 min)
Temp. range min	-60 °C
Temp. range max	100 °C
Glow wire test	750 °C
Thread type	M
Ø Connection thread D	63
Lead	1,5
Length screw-in thread L	18 mm
Ø cable diameter min	34 mm
Ø cable diameter max	48 mm
Key width SW	68 mm
Collar diameter (E)	75 mm
Total length TL	67 mm - 81 mm
Type of cable anchorage	A
Install. torques fitting	30 N m
Install. torques cap nut	30 N m
Impact category	5
Equipment	Incl. connection thread gasket
Product Color	RAL 9005
Type	ESKV-L 63 LT
Order no. RAL 9005	10061502
Packing unit	10
ETIM-Classification	EC000441

Recommended accessories

RDE 63 LT	10063967
BS 48	10064019

24.04.2018

